



Final report of the Motorcyclists & Crash Barriers Project

A project to develop recommendations to Road Traffic Authorities for reducing injuries to motorcyclists in collision with crash barriers.

- *reviews existing research*
- *looks at barriers types*
- *proposes measures to increase safety*



With the support of the Directorate
General for Energy and Transport
of the European Commission

Motorcyclists & Crash Barriers Project Report Index

Introduction

- Initial proposal*
- Acknowledgments*

- 1. Consider existing homologation procedures for crash barriers**
- 2. Review of existing papers & research**
- 3. Consultations with appropriate authorities & intermediate reports**
- 4. Existing measures to reduce risk**
Presentation & evaluation of existing approaches
Homologation procedures of existing motorcyclist friendly crash barriers
- 5. Black spots: where are motorcycle accidents likely to occur?**
- 6. Recommendations for making crash barriers safer for riders**

7. Recommendations: areas for further research

Index of abbreviations

Annexe

List & details of some motorcycle friendly devices identified

Introduction

a. The proposal for the project - Extracts

A proposal for a Project to develop recommendations to Road Traffic Authorities for reducing injuries to motorcyclists in collision with crash barriers, with emphasis being given to low-cost protective measures and preferred crash barrier systems and installation practices

Crash barriers exist to protect road users when they are involved in a road traffic accident. For one group of users however they usually result in greater injuries and a greater likelihood of being killed. The motorcyclist is not contained within a vehicle and consequently it is often the rider that makes contact with the crash barrier, which is made to withstand the impact and absorb the energy of a vehicle weighing up to 40 tons.

The very construction of certain crash barriers in common use, with their exposed, sharp-edged metal posts, the height and profile of their guard-rails, their proximity to the carriageway, and even in some instances, their use of steel ropes as the means of arresting a vehicle, could not be more damaging to a motorcyclist coming into contact with them than if they had been designed with that objective in mind.

The seriousness of the situation is recognised by Directorate-General VII with the question of crash barriers and motorcycles being identified as a priority action in the European Commission's communication "Promoting Road Safety in the EU - The Programme for 1997 to 2001". COM (97)131 final, of the 9th April 1997. The document set out a work programme for Commission action, and crash barriers and motorcyclists feature under Field III- "Reduction of Consequences of Accidents -Forgiving Roadside Design".

Riders' campaigning for improvements

FEMA, as Europe's representative organisation of road-riding motorcyclists, together with our affiliated national riders' organisations, have long been campaigning on this subject. In Austria, France, Germany and Portugal, FEMA member organisations have led campaigns that have resulted in devices being fixed to protect the upright poles of crash barriers in those countries. The riders' concerns have also been raised within FEMA's constructive working relationship with the Directorate General for Energy and Transport of the European Commission.

Research into motorcyclists and crash barriers

The design of crash barriers and their consequences for motorcyclists has been a subject of relatively little research. This, FEMA believes is a reflection of the

ignorance concerning the dangers involved for riders, combined with a perceived low priority. Whilst the situation appears to be improving, with research projects into crash barrier design and motorcyclists currently being undertaken in France and Germany, we are still concerned that there appears to be no coordination and that the issue is still not getting the priority that it deserves.

The Project's aims

This project's aim is to propose practical solutions to reduce the severity of accidents of motorcyclists against crash barriers, and present existing initiatives throughout Europe. It is not an academic study, but through a review of existing initiatives, it hopes to give a good picture of the «state of the art» and provide effective guidelines to reduce motorcyclist fatalities due to crash barriers.

As part of the process of addressing the primary objective of the project **two secondary objectives** have been achieved. The first is an **investigation of recent and current research into motorcyclists and crash barriers**, with the intention of reaching meaningful judgements from a user's perspective. The second has been to identify key issues and **considerations requiring further research**.

The Project's proceedings

The project has been managed by a Working Group of four suitably experienced persons drawn from FEMA's member organisations, together with invited representatives from other appropriate bodies, such as FIM (Fédération Internationale Motocycliste). Regarding ETSC (European Transport Safety Council), despite earlier agreement to cooperate, they unfortunately declined the offer. It was also initially planned that a study on crash barriers and motorcyclists from a medical standpoint which is currently undertaken in Denmark be included in this report, but the local team unfortunately couldn't meet the deadline. Nonetheless an intermediate report on this ongoing research is presented in the report.

The actual work started the 1st meeting of the working group on 19th april 1999.

The project began **by identifying and evaluating all relevant research and statistics**. **Consultations** then took place with a number of appropriate road traffic **authorities** and **road traffic research institutions** and **opinions** sought from a wide range of interested organisations and individuals.

In parallel to this, an Internet web site presenting the project was designed in order to publicise its objectives and collect feedback.

Based on the available information and experience, **measures to reduce the risk of injuries to riders when they impact crash barriers were identified and evaluated**. Strategies have been designed for addressing potential or existing blackspots, and these recommendations are based on actual road situations of these potential blackspots.

In addition to these different road situations the recommendations are also tuned to whether new installation or adaptation of existing installation are considered.

Finally, **areas for further research have been listed**.

Measures and recommendations have been subject to an extensive consultation procedure before being confirmed within this final report.

After circulation of this report and collection of feedback, a 12 page booklet of the recommendations for road traffic authorities will be published as a summary.

b. Acknowledgements

The Federation of European Motorcyclists wishes to record its sincere appreciation for the financial support made available by Directorate General for Energy and Transport of the European Commission. Without their assistance it is unlikely that the Project would have been undertaken.

The help and support of members of the Working Group; Edwin Hofbauer, Rolf Skovloekke, Otakar Vecerka and Robert Tomlins have been of crucial importance at all stages of the Project. Their experience and wide range of knowledge gave a sound factual base for the Project's work programme. Phil Neale, Wim Taal, Trevor Magner and Stephen Prower although not directly involved in the working group have also provided support and helped in key aspects of our work.

Special thanks are due to Reiner Brendicke from IfZ (Institute für Zweirad Sicherheit) and Bernard Lescure from SETRA (Service d'Etudes Techniques des Routes et Autoroutes), who made available a whole range of relevant research on crash barriers as well as offering their knowledge and experience on the subject.

Thanks are also due to ACEM (Association des Constructeurs Européens de Motocycles), and FIM (Federation Internationale de Motocyclisme) for their practical support on several occasions. Moto & Loisirs have also been helping with illustrations.

Finally sincere thanks are recorded for the support and cooperation from all those who at any stage of the project helped, gave their time, comments, or shared their experience to make completion of this report possible.

Eric Thiollier

Secretary of the Crash Barrier Project

February 2000

1. The European homologation procedure for crash barriers

1.1 CEN Norm EN 1317

The road side barriers are normalised under CEN norm EN 1317. The road side barrier's aim is to restrain and redirect uncontrolled vehicles with no harm to their occupant, or other road users. This norm defines several types of barriers according to the type of vehicle it should be able to restrain, and the type of use it is intended for, and the available space on the road.

Testing

Levels of performance are detailed in EN1317 part 2: it defines several test types for safety barriers with different angles and speeds of impact. Vehicles are driven into a barrier and deceleration are measured. Impact speeds vary from 65 to 110km/h and impact angles range from 8° to 20°. Five homologation tests concern cars or light vehicles, whilst 6 tests concern trucks.

Performance level

According to the type of test successfully passed and the AIS (Accident Injury Scale) measured during impact, three scales are defined: T1-3 judges the performance on low angle impacts N1-2 evaluates performance for standard impact H1-4 evaluates the property of the barrier with regards to heavy vehicles

EN1317 part 3 defines the test criteria for crash cushions.

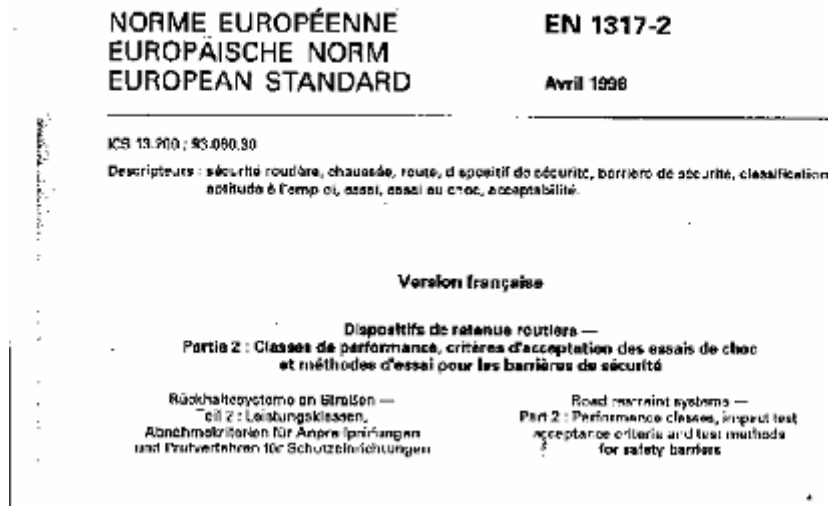

1.2 Considering EN13 17 and crash barriers from a motorcyclist view point.

No mention of motorcycles or motorcyclists is made in EN 13-17. FEMA believes this is a major issue and that motorcycles should be accounted for within EN13-17 part 2, and a specific test designed.

Indeed, from a motorcyclists point of view, metal crash barriers are a extremely dangerous obstacle, that can turn a fall into a fatal accidents.

As research has shown, and as detailed further, posts supporting the barrier have been identified as the main impact point. A piece of research even describes how, during an accident, an I shaped post sliced through a crash helmet like knife in butter, resulting in the instant death of the motorcyclist.

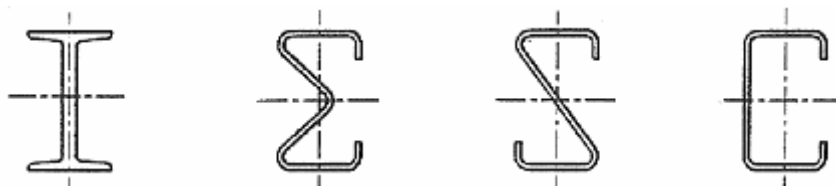

IPE post. Cheap to build, they also present the most aggressive edges to riders.

Sigma, Z-, or C- shaped posts are an easy improvement to the IPE 100. Less aggressive in aspect, they still represent a danger to a fallen motorcyclist.

Indeed, posts supporting the guardrails have edges that act as razors when hit at speeds above 30 km/h. A motorcyclist falling off his bike in a bend will slide inexorably towards the side of the road, resulting in an impact on the barrier post.

Biomechanical constraints acceptable by a human body are often exceeded. Limbs can be cut off; and victims might bleed to death.

1.3 Energy absorption: the bio technical side

Abbreviated Injury Scale (AIS):

AIS Severity

- 1 Minor
- 2 Moderate
- 3 Serious
- 4 Severe
- 5 Critical
- 6 Maximum (Unsurvivable)

The AIS scale reflects the 'life-threatening' character of injuries.

Some concerns about this scale have been expressed as it is not adapted to motorcyclists. Notably, it 'under-scores' crippling leg injuries (or leg injuries that are followed by amputation) as being serious, but not «life threatening» injuries.

2. Review of existing papers & research

(Also see Annexe I: List of related studies identified)

Although the list of research related to crash barriers or motorcyclists seems well furnished (23 in total), they are often ancient, and few papers are really relevant to the specific case of motorcycles and Crash Barriers (CBs). Furthermore they often refer to the same fundamental research.

However, we managed to identify a group of research/studies that, in addition to being recent and relevant, have followed up the fundamental research which studied the effects of impacts on bodies with crash barriers from a medical standpoint. Areas for further research are detailed under [point 7](#). All studies recognise the specific dangers of crash barriers with regard to motorcyclists. The post supporting the rail being the main impact point and critical area.

2.1 Etude des accidents de motocyclistes avec choc contre glissières de sécurité. (Brailly 1998)

This is the most recent & detailed study of 418 motorcyclists accidents against crash barriers.

The accidents of motorcyclists against metal crash barriers in France in 1993,1994,1995 totalled 188 fatalities (63/year), 342 serious injuries and 385 slight injuries. This compares with the average figure of 800 motorcyclist fatalities per year at the same period.

The results showed that the risk of fatality per accident against a CB is five times as great as the national rate for all motorcycle accidents and account for 8% of all motorcycle fatalities and 13% of fatalities on rural roads.

The conclusions identify **curves** as **specifically dangerous areas**, with accidents **on the external radius**. It recommends creation of an obstacle-free zone between the road and the barrier. This would allow deceleration before impact with the crash barrier and, as a secondary effect, would benefit other categories of road users as well.

The report also shows that the use of a screen on barriers is a way to halve the number of motorcyclist fatalities against metal barriers.

In the countryside, accidents involving motorcyclist colliding with metal crash barriers represent over 30% of the total number of motorcyclists killed in accidents against an obstacle.

The study shows however that kerbs of pavement and central islands are an also a worrying situation in urban areas, in roughly the same proportion.

2.2 IfZ conference 1998: Guardrail post-protection for improving the safety of motorcycle riders by Uwe Ellmers (BAST)

This report demonstrates the severity of injuries of motorcyclists against crash barriers, showing that the **probability of being killed rises from 2,2% to 10,9 % when the roadside is fitted with a crash barrier**. The report recommends Sigma posts instead of I posts, and the fitting of crash barrier protectors. A number of other reports from that conference recommend creating an obstacle free zone next to the road and moving roadside furniture away from the road. This is preferred to installing a crash barrier as protection against these roadside obstacles.

2.3 What goes wrong in highway design (and how to put it right)

Although this is not specifically about bikes or crash barriers, this 22 pages booklet, published by the British Automobile Association, provides guidelines for simple road safety audit and proved to be a good model for the recommendation leaflet of our project.

2.4 Passive Sicherheit von Schutzplanken by Martin Dohman (1987)

Accident data: Research in Tuebingen between 1/01/84 and 31/12/84 shows 16% of all motorcycle fatalities were linked to a collision with CBs

Westfalen-Lippe 1980 to 1982: One in 6 PTW (Powered Two Wheeler) to CB collisions resulted in serious or fatal injury

The solutions recommended indicate that installation of a second rail is particularly effective at shallow angle collisions. This is supported by the tests undertaken by LIER / INRET (see [point 4.2](#)) Crash Barrier Protectors (foam covering metal posts - see [point 4](#): existing measures to reduce risks) is indicated as a cheap & flexible alternative. Sigma shaped posts are shown as less aggressive

Focusing on black spots: 100% protection is not recommended due to being economically ineffective. Equipping 10% of all CB equipped roads with a Motorcycle Friendly Device (MFD) offers a reasonable cost benefit ratio.

On Autobahns: less than 10% would be required as the equipping of CBP on central reservations would not be required. On all other roads, CBP equipment is recommended in special sections, ie. where accidents have been reported or are very likely to occur. Contrary to Brailly 88, this study states that this is not necessarily the case in small radius curves.

2.5 Neuentwicklungen von passiven Schutzeinrichtungen by Rainer Kehrein (1985)

In 1979/1980 Concrete walls started to be built on European roads as an alternative to metal crash barrier. This came in Germany via USA and France. Advantages: metal rails are damaged in a collision and must be repaired, whilst concrete walls do not. They also have an additional noise absorbing effect which can be of benefit in urban areas.

2.6 Schutzeinrichtungen an Bundesfernstrassen by Robert Schnuell et al

This paper shows that collisions against a Crash Barrier causes twice the severity and 5 times more lethal injuries compared to all other PTW accidents. Research concludes that protection of all CB sections where accidents have occurred could save 25% of all motorcycle deaths and result in a 50% decrease of accident severities.

2.7 Anprallversuche an Leitplanken mit Dummies by Peter Jessel

Previous findings reviewed by this piece of research show that typical injuries from PTW/Crash Barrier collisions are

- Fractures
- Open Fractures
- Serious internal injuries
- Amputations

Evaluation of impact attenuators fitted to crash barrier posts. Impact deceleration measurements show that impact attenuator halve the impact deceleration, halve the impact force and double the impact time (in milliseconds)

The biomechanical tolerance of deceleration for a chest impact is $600-800\text{m/s}^2$. This figure was exceeded with the unprotected post (860m/s^2), but with the protected post, deceleration was only 472m/s^2 . This shows that the polystyrene protector can turn a fatal accident into a accident causing only slight injuries.

2.8 Motorcycle impacts with Guardrails (Robert Quincy, Dominique Vulin and Bernard Mounier (INRETS) (1985)

This study covered three years and 940 km of highway (A6, A7, A9 highways in France) Concentration of impacts on access roads and interchanges was noted but this also corresponds to lower severity. The report concludes that in critical accident areas 50% of the guard rail cost could be assigned to its improvement.

It also further refers to:

- Cayet J.C., Chretien B «Accidents de deux roues heurtant un dispositif de retenue». Rapport ONSER N°311-79-03 from April 1979

- M.Lardet «Contribution à l'étude des accidents de deux roues avec heurt de dispositifs de retenue». Thesis on Doctor of medicine degree. University of Paris North - 1984

2.9 VDI-Berichte Nr1159, 1994 by U, Ellmers

This report widely refers to a previous one (DOC:BASt FP 8726) from Prof Robert Schnuell UNI Hannover 1992.

The research shows that Sigma 100 posts under comparable conditions just cause bruising where IPE-100 posts cause fractures or amputations.

The rest of this paper describes the content of the TU-SPL 93 which is an official document on the demands on delivery specifications of Crash Barrier Protectors (CBP). This document was implemented in 1993 in Germany.

2.10 The safety value of guardrail and crash cushions, by Rune Elvik, Institute of Transport Economics, Norway.

This study makes the point that «*guardrails should be installed only where the consequences of striking the guardrail are judged to be less serious than striking the guarded object*». This simple statement is far from always being applied, as we can see from guardrail set in front of an open field. No rail here equals a best ever «low cost solution».

2.11 Vehicle impact tests on a hedge of Rosa Multiflora Japonica by I.B.Laker RRL 1966

This study dates from 1966 but the results are still very interesting for our purpose. It shows, through impact tests on a hedge of Rosa Multiflora Japonica, *that even though a 3 metre shrub barrier is not sufficient between motorway carriageways to stop fast moving cars, it may be sufficient if made wider or if used on slower roads...*

Tests were made with a car weighing 2475lb and going through the hedge. Deceleration measured 0,45 g, similar to that obtained by fairly firm braking. These results are far from being sufficient to stop a car or a small truck but seem very encouraging if applied to a human body weighing 15 times less.

Such a hedge would also cut out glare from approaching headlights at night.

The plant used for the tests is the Rosa Multiflora Japonica (the blackberry rose). It has a shallow tuberous root system producing many shoots from which branches develop into long tendrils which interwine to form a dense resilient hedge with good anti dazzle properties; it is thornless. The initial cost for supplying and planting was about 35 £ (1966) per 100 yards for a hedge four shrubs wide, which on maturing had an effective width of 15 to 20 ft. The shrub does not produce runners so that maintenance of the hedge consists of occasional pruning.

Specific testing with bodies/dummies would be required to test the impact absorbing properties of this approach with regards to motorcyclists.

2.12 Essais biomécaniques concernant la protection passive contre les accidents d'utilisateurs des deux roues motorisés lors du choc contre les supports de glissières de sécurité. By Dr Georg Schmidt from Heidelberg University (1985)

This is one of the fundamental research into impact attenuators, where cadavers have been projected against barrier posts.

The tests simulated an accident where a motorcyclist would be sliding on his back, feet first, at an angle of 15° against a barrier post. The CBP are designed by Schutzplanken-Produktions GmbH in Schmelz-Limbach. Tests performed at 32 or 33 km/h show that the AIS is 4 without CBP, but goes down to AIS1 or 2 with CBP.

Sigma shaped posts are also shown as a way to reduce injuries.

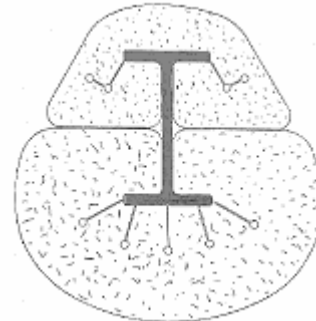

IPE 100 post covered with impact attenuator

2.13 Report on Motorcycle Safety by European experimental vehicles committee (12/1993)

Identifies **support posts** of safety fences and barriers as particularly aggressive to motorcyclists, and recommends that consideration be given to providing energy absorbing surface for these in locations where there is a likelihood of motorcycle impacts: AIS is halved when a post is covered with appropriate energy absorber.

2.14 Motorcycle Accidents with guardrails by Hubert Koch and Reiner Brendicke, Institute für Zweiradsicherheit (1988)

To avoid fatalities and to reduce severity of injuries, this research paper proposes the following solutions:

- fitting of «sigma-shaped» posts instead of IPE-100 posts (Fig. 1)
- fitting of special impact attenuators to guardrail posts. (Fig. 2)
- fitting of an additional W-Beam (Fig. 3)

Referring to several other research papers on biomechanical tests, this paper advocates use of impact attenuators, of which approximately 25 000 have been fitted in the Federal Republic of Germany. Additional lower rails seem to reduce not only accident severity but also the number of accidents.

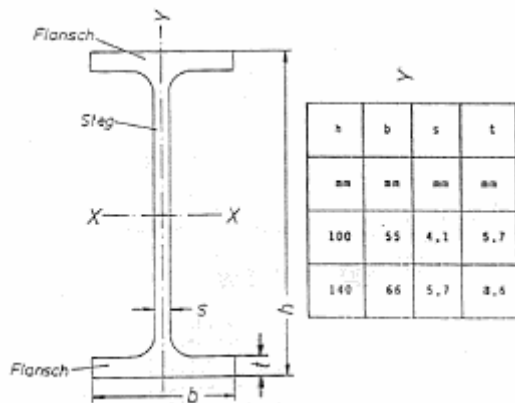

Fig. 1: IPE-100 guardrail post cross section

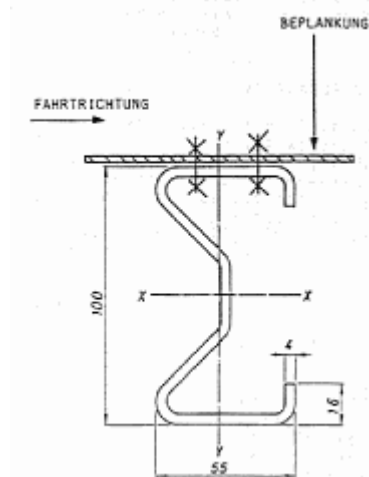

Fig. 2: Sigma guardrail post cross section

Results of cost-benefit studies are presented, which prove that under certain realistic conditions, the implementation of protective measures is to be considered positive:

Such additional protective devices can be justified only in accident black spots, representing considerably less than 10% of guardrail sections. The report estimates that median barriers can be generally omitted. It also states that from a cost-benefit point of view, impact attenuators should have priority over fitting of a second lower rail.

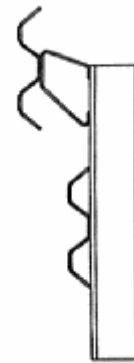

Fig. 3: Fitting of an additional W beam

2.15 Environmental Hazards in motorcycle accidents by James Ouellet from Traffic Safety Center of University of Southern California

This piece of research provides a more general approach of motorcycle safety and roadside design. Motorcyclists are shown as particularly vulnerable to any imperfections in the road surface that affects stability. The report describes the differences in approach from a car occupant or a motorcycle rider.

2.16 Statistics: Number of accidents of motorcyclists against crash barriers in the Netherland (from 95 to 98)

Month	lethal	injuries	material	total
jan	1	1	6	8
feb	2	4	3	9
mar	1	10	4	15
apr	3	16	11	30
may	2	21	5	28
jun	5	15	8	28

jul	2	18	8	28
aug	2	25	14	41
sep	3	19	9	31
okt	1	17	10	28
nov	0	10	7	17
dec	1	1	1	3
total	23	157	86	266

These figures indicate a greater severity of this type of accident.

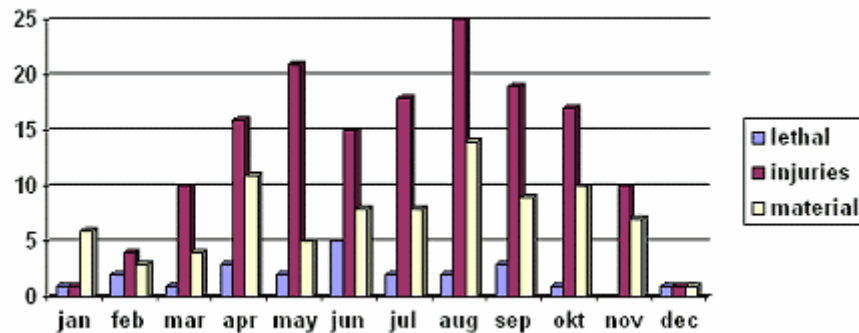

2.17 Statistics: Accident figures of motorcycles vs crash barrier in the Austria (90-96)

	All accidents	Accidents with crash barrier	% of accidents in relation with crash barrier
Total number of accidents	20937	1087	5,2%
Fatal accidents	641	75	11,7%

The figures from Östat (Austrian bureau for statistics) also show that 40 % of accidents motorcycle accidents with a crash barrier end with severe injuries.

11,7% of Motorcycle fatalities are linked to crash barriers. But Östat warns of difficulties in collecting data and attributing cause of death, so the actual figures could be far higher.

2.18 Study of motorcycle accident against crash barriers in Denmark, by MSCG

This research was originally intended to be an integral part of this report. Unfortunately, difficulties to meet deadlines did not allow this. This ongoing study concerns accidents from 1993 to 1997. The number of accidents is small in statistical terms but is useful to identify types of accident and severity. Intermediate report indicates that 10% of motorcyclists who leave the road hit a crash barrier, and 20% of these die because of the crash barrier while 60% of them get seriously injured.

3. Consultations with appropriate bodies and experts

3.1 Report from a discussion with Dr Michelle Ramet INRETS (7 september 1999)

Michelle Ramet is a doctor who was involved in a French crash barrier project as medical expert for road accidents.

Michelle Ramet described the French homologation procedure for motorcycle friendly devices: a dummy is thrown against a barrier at a 60 km/h speed with an 30° angle. The dummy is sliding on its back and hits the barrier head first. (See Annex V)

Neck injuries are measured through HIC, compression, traction and shear. These criteria are measured with a dummy originally intended for testing car accidents and adapted to motorcycle accident.

According to Michelle Ramet, the number of accidents of motorcyclists against crash barrier is insufficient to make conclusions at that stage. It cannot be concluded whether the testing procedure is relevant. Measuring compression in the neck area is relevant, but others criteria are probably less relevant. *«In real life situation, it is difficult to say if motorcyclists die from neck injuries anyway. We should start by studying motorcycle accidents to then be able to design a dummy relevant to motorcycle accident testing.»*

According to Dr Ramet, information is insufficient at this stage to prove if motorcycle-friendly devices are doing any good. For example says Dr.Ramet: *«Concrete wall is no better than metal barrier. With metal barrier you have at least a chance to slip through between two posts. On the other side German/Austrian CBP are as effective when impact speed is over 30 Km/h»*

The question is to find a study comparing accidents against:

- concrete wall,
- metal barrier,
- metal barrier fitted with «motorcycle friendly device».

in comparable conditions (road type, weather, context, time of day...), or to perform such testings through experimentation.

3.2 Report from meeting With Bernard Lescure Friday 10th september 1999

3.2.1 Background

Bernard Lescure is a senior engineer from the French SETRA (Service d'Etude Technique Routier et Autoroutier) responsible for recommendation of road design in non built up areas.

He has been conducting the technical aspects of the new French homologation procedure of "motorcycle friendly crash barrier"

These devices were designed after a competition into innovative design for motorcycle crash barrier was launched in France following a demo from the French rider's rights organisation FFMC asking for better roadside safety.

3.2.2 French testing procedure of «motorcycle friendly devices»

Mr Lescure was able to give some information on the testing procedure designed to evaluate the different «motorcycle friendly devices». Details on this procedure can be found in annexe V «Protocole d'essais de dispositifs de retenue assurant la sécurité des motocyclistes».

HIC (Head Injury Criteria), compression & shear are measured on a dummy thrown against a crash barrier post, equipped with «motorcycle friendly device».

Impact	Speed:	60km/h	+5%
Angle:			30°±0.5°

The testing was performed in LIER (Laboratoire de l'INRETS pour l'Équipement Routier), located near Lyon.

The LIER had to work out some working hypothesis that can be improved, according to the accidents that will be reported.

Costs

The cost of one such test is estimated at 80 000 F HT (#12200€). Two must be performed with different angles of the dummy. One additional testing must be performed with a car to check that performance with regards to cars are not hindered. Costs = 120 000 F HT (#18300€).

No testing has been done against a bare crash barrier (not equipped without motorcycle friendly device). Bernard Lescure explained that the dummy would break with no significant results obtainable but high costs involved.

Reproductibility of testing procedure was not evaluated

3.2.3 Motorcycle Friendly Devices existing in France

In France, the only device existing prior to the competition into innovative design for crash barrier was the «écran inférieur motard» designed by a company named «SEC-Envel».

The testing performed prior to the authorisation for use was to make sure:

1. a dummy thrown at it could not hit the posts
2. this device should not hinder the properties of the barrier with regard to cars.

(ie there was no evaluation of the reduction in accident severity)

New devices

Following that competition into innovative design, three new devices were designed under the NEW homologation procedure:

Rail-plast	from	Sodilor	company
Moto tub	from	Sodirel	company
Moto Rail	from	Solosar	company

These three devices, in addition to the «écran inférieur motard» from SEC-Envel are described under [point 4.2](#): Existing measures to reduce risks

All 4 devices were tested and gave satisfactory results.

Concrete walls

Two types of concrete walls were also tested. The New Jersey profile (see fig 7- page 21) gave satisfactory result but HIC was

very close to 1000.
The experimental profile illustrated in fig 8 (page 21) was tested and gave HIC well above 1000.

Prices for these devices are high (effectively doubling price of crash barrier), but costs could go down if use was developed (economy of scale).

From Bernard Lescure's point of view concrete walls are not considered to be very «motorcycle friendly». Although bodies are not torn apart as with metal post impacts, he believes impact severity is too high to be considered safe for motorcyclists.

Wire Rope Safety Fence (Cable Barrier)

Regarding the cable barrier (ie Brifen), Bernard Lescure thinks the problem with regard to motorcycle accidents is similar to the metal crash barrier but not any worse.

The Moto Tub motorcycle friendly device might be adapted to fit also as a protection under a cable barrier. The cable barrier's main advantage is the low maintenance costs and good impact absorbing properties with regards to cars.

Polystyrene crash barrier protector

According to Bernard Lescure, these can be useful in the case of low impact speeds, such as those found in urban areas or tight bends.

COMPUTER SIMULATION

This can be a valuable tool to help design barriers or compare different impact situations, but is not enough to homologate them. It requires highly qualified professionals and sophisticated modelling.

Bernard Lescure also supports creation of safety zones alongside the road. Norms exist and are specified for the following zones using the following terms and definitions.

- Zone de récupération: Zone bitumée ou pas de 2 mètres de large, vide d'obstacle de part et d'autre de la route.
- Zone de sécurité: zone de 4 à 7 m de large vide d'obstacles, ou sur laquelle tout obstacle doit être protégée par une glissière de sécurité.

Shrubs - Bushes

The idea of finding a type of a shrub, to plant on road side to absorb kinetic energy of fallen motorcyclists was commented on favourably as unusual but interesting.

3.3 Otakar Vecerka: motorcycle safety on a race track.

Consulting Otakar Vecerka, member of FIM (CMT), the world leading body for motorcycle sports, gave the trackracer's point of view:

«On a race track, verges are the outer parts of a track's transversal profile. (...) They contribute to higher safety by improving visibility (...) and may serve as an area in which vehicles can be brought to a halt.»

«Additional protective devices may be permanently or temporarily used to protect rigid obstacles. The devices used must be homologated by the FIM.»

A number of systems are homologated, classified in different categories such as Type A - air fences, Type C - straw bales, Type E Tyre barrier.

From «FIM standards for road racing circuits»

However the costs of such devices are in Otakar Vecerka' point of view much too high too be viably used on the road.

4. Existing measures to reduce risk

4.1 INTRODUCTION: Presentation of existing approaches

Crash barriers and road side design are an area where the differences in the approach to road safety from car and motorcycles users are almost diametrically opposed. Where the motorcyclist is taught and tries to prevent accident from happening, road safety experts also try, through passive safety, or secondary safety measures, to reduce consequences of an accident to car occupant.

However, the following examples show that initiatives and devices exist to satisfy the needs of both the motorists and the motorcyclist. The first two focus on the ways to reduce consequences of a crash against a metal barrier, the third looks at a more general concept of road side design, whilst two alternate approaches are presented.

4.1.1 Reducing the impact severity: Crash barrier Protector (CBP)

Two models of crash barrier impact attenuator covering barrier posts exist. They are made of foam (polystyrene, polyurethane or similar material). They have been installed on several hundred of kilometers in both Austria and Germany. Some have also been used in Luxembourg.

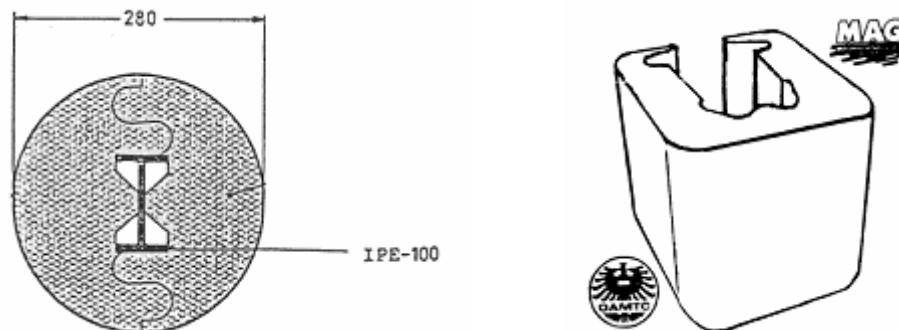

Dohman (1987) reported that protective devices of these types have been installed on about 80 kilometres of guardrail in several federal states of Germany.

They prevent contact with posts edges, and absorb part of the impact energy. Their positive effect is however reduced with higher speeds of impact. They are very easy to install, and the indicated durability is 4 years. In mountainous regions, they are often removed during winter to prevent damage by snowplough.

Annex VII summarizes the different existing models. Recommendations for use depend mainly on the profile of the post.

In Portugal, some initiatives by riders' groups have been reported: they installed used tyres on the posts of metal barrier in the hope to reduce severity through masking the edges of the posts.

4.1.2 Preventing contact with the posts: «Shield» approach

The metal «Shield»

Since the early 80s, a device made of a metal plate fixed under the rail to prevent contact with the barrier posts has been designed and is used in France (sold by company SEC-Envel). Nearly 100 km of motorway have been equipped with such devices in the Paris region in 1997. This is a different approach to the additional beam illustrated on page 13, as the beam is flat and has a degree of flexibility to absorb kinetic energy of the impact. 500 km of such rails have been installed so far in France.



The plastic «Plastrail»

A new device has been recently developed by French «Sodilor» company in the context of the French competition for innovative design of motorcycle friendly crash barriers. Its aims to combine the energy absorption property of the CBP with the impact spreading property of the metal sheet. It consists of soft plastic fence covering barrier posts. It is adaptable to existing crash barrier system.

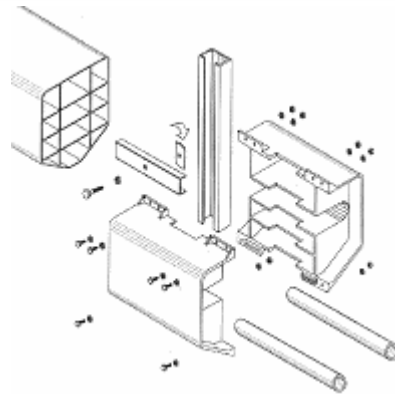

Motorail

An integrated solution with a built in secondary rail, and minimal aggressive shapes, turned in edges, etc... This device has been designed and is sold by the company Solosar.

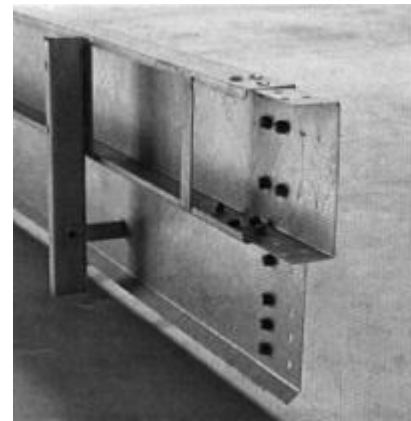

Mototub

Adopting a similar approach as the above «Plastrail», but comprising 70% recycled material, Mototub is presumably also adaptable to a cable barrier. The company selling this product is Sodirel.



THESE four devices have been homologated and approved for use on the French territory following the procedure described under 4.2.1. A programme of

equipment of such devices has been launched in France, with annual budget of 20 millions francs (3 000 000 €)

4.1.3 Roadside design approach (clearing the road sides of obstacles)

To a rider used to French and German motorways, where the crash barriers are built immediately adjacent to the road, Belgian motorways appear to be significantly safer in the event of a fall. An obstacle free area of several meters exists between the side of the road and the barrier. To a motorcyclist, this is an area for deceleration before impacting the posts



of the barrier. Furthermore shrubs are planted on the central reserve, offering an additional kinetic energy absorbing cushion for the unlucky motorcyclist.

In Holland, **in urban areas**, the presence of cycle lanes on the side of the road, acts as an fixed-obstacle-free safety zone where a rider falling can land without hitting roadside furniture (roadsigns, traffic light), or being ran over by a car. Edges of sidewalks can be cut to reduce aggressiveness of shapes. (see p.28 fig.10)

4.1.4 Concrete Walls

Presenting a flat surface with no sharp edges the concrete walls have the advantage of replacing a point impact with a surface impact. Consequently, they appear a lot safer to a motorcyclist, especially with small impact angles (<math><20^\circ</math>).

They cost more to install but less to maintain than the standard metal barrier. Concrete walls also have the property to prevent heavy vehicles from crossing into the opposing traffic lane. As a consequence they are often used on central reserves, or where there is no room for a metal barrier to deform.

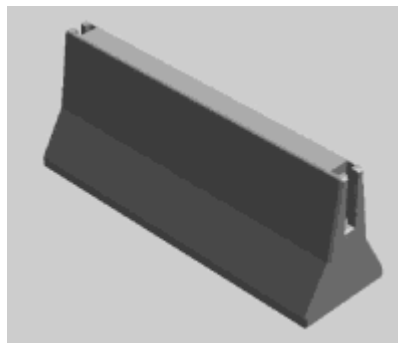

The main problem is the lack of kinetic energy absorption capability, be it for a car or for a human body. As a side effect the concrete walls absorb a part of the traffic noise. They are of little use in the nordic countries as they tend to favour accumulation of snow on the road and make «de-snow-ing» operations more difficult.

As was proven by testing at the LIER in Lyon, **the profile of the concrete barrier has a great consequence on the severity of injuries** when impacted by a human body under the procedure described in 4.2.1.

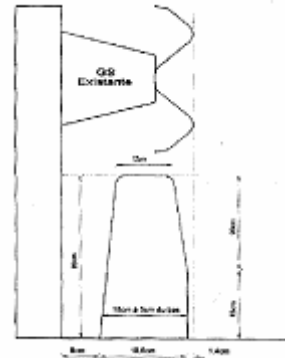
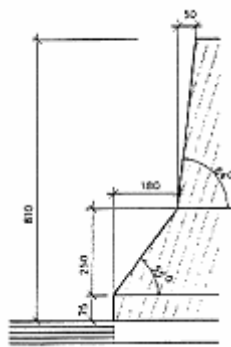
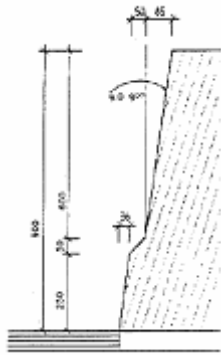

Fig. 6: «STEP» profile Fig. 7: «New Jersey» profile Fig. 8: «experimental» profile

4.2 Review of homologation procedures of crash barrier protectors

All these different approaches to «motorcycle friendly devices» have been tested. But it is difficult to compare the effectiveness of the different approaches because these devices have been tested by different methods, and with different homologation criterias, as described below.

4.2.1 France: LIER / INRETS homologation test for secondary rail

The French INRETS - LIER test for homologation of «motorcycle-friendly» barriers is done with dummies sent against fitted barrier with impact speed of 60 km/h, and 30° angle. Criterium for homologation is HIC < 1000. (Full details on the homologation procedure can be obtained from the LIER located in Bron (69) France).

The standard homologation test for cars (110km/h, 20°, 1500kg) is also performed in order to check that the device does not hinder the properties of the barrier with regards to car (We strongly wish this concern would work both ways: that devices intended to improve car impacts safety would be tested to check that they do not damage motorcyclist safety).

4.2.2 Germany: BAST homologation procedure for impact protector

The test has been designed by BAST (Bundes Ansalts für Strassenwesen - German Federal Bureau for Road Safety). Deceleration during impact against CBP is measured. The test states that deceleration should not exceed 60 g as peak value, and 40 g over a 3ms interval. It sets two classes of devices, Class 1 are tested with impact speed of 5.5m/s (20km/h) and class 2 of 9.7m/s (35km/h).

4.2.3 New materials for improved safety?

Cellbond Composite, a UK company specialised in energy absorbing device is studying several projects to adapt their product to crash barrier protector.



Pressload energy absorber

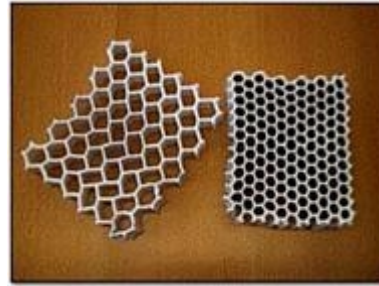

Honeycomb energy absorber

The main interest is the ability to tune the energy absorbing capabilities to whatever desired level, by changing size, thickness, material, or number of layers. According to the company, durability and cost effectiveness are better than polystyrene foam.

4.2.4 General remark on homologation impact speeds

Whilst indicated impact speed might appear low compared to the speed of traffic on a motorway for example, the impact speed is usually reduced significantly between accident and impact against barrier, through abrasion on road surface. This was demonstrated when designing the INRETS-LIER homologation test (the road surface had to be made slippery for the dummy to actually reach the barrier).

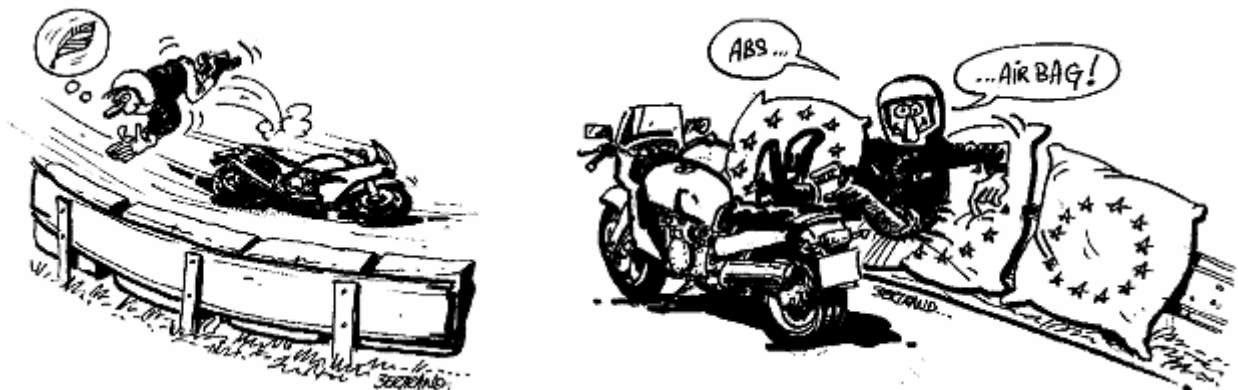

4.3 A special case: the cable barrier (Wire Rope Safety Fence).

Little data exists on this type of barriers, and few motorcycle accidents against them have been reported. They are however widely criticised by motorcyclists as being a human scale «cheese cutter» roadside furniture. As posts have been identified as the main danger to motorcyclists impacting roadside



Wire Rope Safety Fence: here, one of the cables is not in place, following an accident

furniture, WRSF theoretically represent the same danger as the standard metal barrier. However these lend themselves more readily to the addition of protective system mentioned in 4.1 & 4.2. Thus WRSF represents the worst choice in a motorcyclist's viewpoint: it seems difficult to improve their safety with regards to a motorcyclist at a reasonable cost.

Nonetheless, we draw attention to Mr Johansson, a swedish inventor who has designed devices to cover the cables and reduce the «cheese cutter» effect. However the aluminium cover of the cables does not provide protection of the posts.

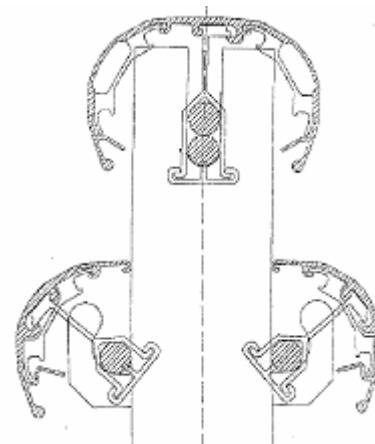

5. An audit procedure for identifying black spots?

Cost effectiveness considerations for protective measures

In France, Ministry of Transport estimates the cost of equipping all crash barriers with motorcycle friendly devices would be 600 millions euros.

With an average of 60 motorcyclists death due to crash barriers and a pessimistic hypothesis that these devices would halve the number of motorcyclists' fatalities against crash barriers, this would save 30 lives. With an estimated cost for society of 1 million euros for 1 road fatality, it would take 20 years for a full installation to be cost effective. With the given figures for durability of MFD, this seems economically not sound. Therefore the need to focus on "black spot" areas where accidents are likely to occur.

Where are motorcyclists impacts against crash barriers likely to occur?

This question is very difficult to answer in definite terms. Even the research conducted by MC Brailly on over 300 accidents could only draw very general guidelines about motorcycle/crash barrier accident blackspots. An accident can happen anywhere. An audit procedure identifying specifically all road situations where motorcycles accidents in conjunction with Crash Barrier will occur is not

feasible precisely. Furthermore, the difficulty of designing guidelines applying from Oslo to Athens or from Wien to Dublin is obvious. Finally, the possibility of making roadsides safer for motorcycles will depend mainly on the priority and budget allocated to this item on the Road Safety Agenda of appropriate authorities.

Nonetheless we managed to put together a set of practical and guidelines. Cases where specific motorcycle friendly barriers should be installed have been identified, whether on new constructions or existing installations. These recommendations, detailed in [point 6](#) are also made according to road location, type, situation, or motorcycle traffic.

It should be kept in mind that a good amount of common sense, or personal appreciation is needed, to judge the best motorcycle friendly approaches according to each particular roadside situation. Usually, the local authorities responsible for road maintenance or building have the best knowledge and are in the best position to judge the spots that should be equipped in priority

It must be noted that crash barriers are usually constructed (or at least should be) in potentially dangerous areas, sharp curves, danger zones areas. This multiplies the risk for a motorcyclist, especially in bends, acceleration or deceleration areas, where stability of the bike is at stake and skidding more likely.

Bends

Roadsides of bends and curves are often equipped with crash barriers. But a powered two wheeler is especially vulnerable in these areas. This is due to the necessity of leaning the bike to counter centrifugal forces. While the bike is leaning it is critically vulnerable to skidding, whether this would be caused by poor road surface, diesel spill, weather conditions, gravel, or mishandling of the bike. Changing the path of a bike while in a curve is a delicate maneuver. The same applies to breaking while in a curve. Thus bikes often use more of their lane to help "straighten" the bend.

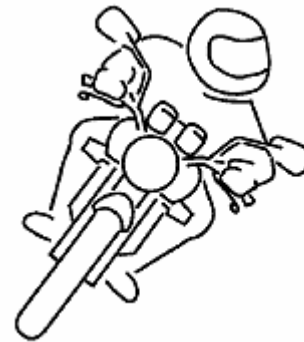

The amount of leaning necessary increase when radius of curve is small (ie tight curve), and speed is high (to counter centrifugal force).

There is a specific danger when radius of the curve is not constant, especially with decreasing radius.

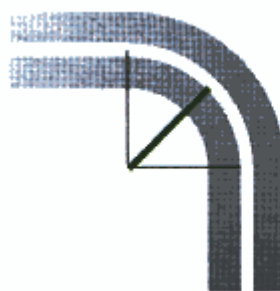

Radius of curve: 100m

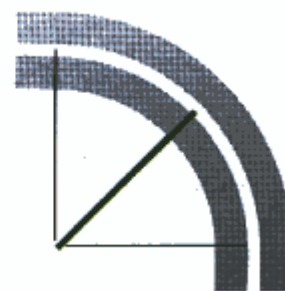

Radius of curve: 200m

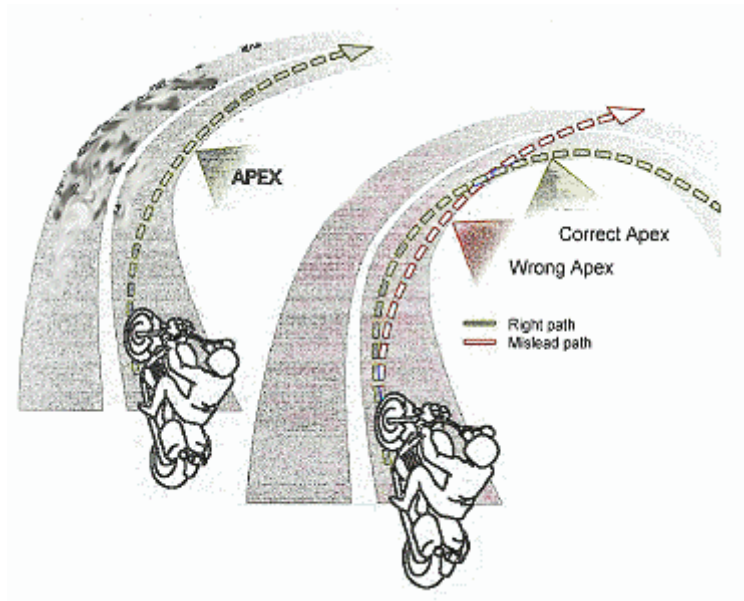

Standard curve

'Tricky' curve



-- Examples of curves that can cause specific safety problem to a motorcyclist. --

When radius of the curve is not constant and is decreasing during the course of the curve, it requires change of path for a motorcyclist. This is a hazardous maneuver for a leaning motorcyclist and specific protective measures should be taken in such curves.

Example: Priority actions taken with regards to motorcycles and crash barriers in France

The directives given to regional road authorities by the French Minister of Transport summarise the areas to be equipped with motorcycle friendly devices as a priority.

- On motorways in curves with a radius less than 400m on the exterior.
- On normal roads, in curves with a radius less than 250m.
- On all roads, where there is banking in the road

This applies to new installations.

For existing installations, an annual budget of 15 MF (2,3 million €) has been allocated to fitting MFD in black spots areas.

A programme aiming to fit existing crash barriers with MFD in areas of regular motorcycle meetings has also been launched with an annual budget of 5MF (760 000 €).

It can be noted that according to the Road Safety Department of the French Transport Ministry, 15% of crash barrier are useless and could be simply and completely removed (i.e. it would be safer to exit the road into a field than to crash into the barrier).

6. Recommendations for replacement and adaptation of crash barriers

Although the specific dangers of crash barriers to a motorcyclist have been recognised for a long time, very little has been done to improve the situation. 'Forgiving roadsides' is a concept limited to four wheeled vehicles.

Ideally, metal crash barriers should be equipped with protective measures for motorcyclists everywhere. But realistically, this is difficult to achieve in terms of economic feasibility. "you've got to start somewhere!" is the moto. So based on all the research that has been studied, as well as on the experience collected, the following recommendations are given in order to take protective measures where they are most likely to save lives.

6.1 New installation: road side design.

Although improving the safety of one category of road users should not be made to the detriment of another, as seems the case with crash barriers, practical and cost effective measures have led to favouring the approach with regard to protecting car occupants.

Road Safety policy in the 60s' were aimed at reducing the high number of fatalities, and metal crash barriers were a simple and easy improvement. However, the generalisation of metal crash barrier overlooked the motorcyclist' specific situation.

The examination of motorcycle safety and crash barrier research has resulted in a realisation that it is necessary to consider *roadside obstacles in general*: a crash barrier is generally installed only to prevent vehicles from hitting other obstacles located behind it. To comply to a motorcyclists' needs with regards to an accident, the concept of road side design needs to be reviewed. Indeed, a high number of other piece of roadside furniture or other natural obstacles are also at stake.

Creation of a safety zone, on both sides of road, free of obstacles is recommended. This gives some extra leeway from a safety zone between roadside and barrier. This would be particularly crucial on exterior of bends with a radius of less than 250m. This has the strong advantage of benefiting all road users as well as allowing planting of shrubs in that safety zone as advocated by RRL research by I.B. Laker (See [2.10](#)).

Wherever this safety area for deceleration / leeway area is not available (no room for safety zone), and the crash barrier has to be constructed closer to the roadside, two options are possible to increase motorcycle safety:

- Concrete wall significantly improves motorcyclists' safety. However, this must be balanced with the concerns of other road users, as well as other criterias (costs, snow).
- Fitting, in the exterior of curves of Motorcycle Friendly Device is the recommended way to improve safety and survival probability for motorcycle riders in case of impact against the barrier.

Recommendations (General)

A crash barrier is an obstacle in itself. The decision to install it should only be taken if other means of removing the obstacle it protects are impossible or prohibitively expensive, and if the barrier itself is not a greater danger than the obstacle it is intended to protect.

Removing roadside obstacles is preferable to protecting them with crash barriers

Making roadside obstacles more fragile, with, for example, collapsable road sign is another alternative and should be an area for further research.

When a crash barrier is needed for the safety of cars, then a number of devices intended to improve the safety of motorcyclists have been tested and homologated. It is very expensive to correct mistakes once they're done. Incorporating the cost for motorcycle friendly device from the start is the best way to save money, and lives.

On new infrastructure, reducing the risk of a fall by good road layout and visibility, less changes in curves radius is a priority objective.

'I' shaped posts (IPE 100) should not be used in new installations and when damaged should be replaced with less hazardous types of post. When they exist, they should be fitted with an impact attenuator. Research has shown that they cause very serious injuries, even to the head when crash helmets are worn.

6.2 Existing Installations

Existing installations: Upgrading motorcycle safety in the relevant areas

A direct impact in saving lives or reducing accident severity can be achieved when funds for fitting MFD is appropriately allocated. If these MFD are installed in relevant areas (ie black spots) where accidents are more likely to occur, the return on investments sharply increases. Costs for MFD if internalised at an early stage and in greater volume can dramatically reduce costs. Budgets should be allocated by the appropriate authorities to allow implementation of these measures.

Recommendations: practical guidelines

As stated earlier, fool proof recommendations are difficult to make. But there is no room for contemplacy, and the dangers identified need to be adressed: you've got to start somewhere.

The following strategy is proposed. It requires riders group's input at the local level in order to prioritise the needs for motorcycle friendly devices and adress the potentially most dangerous spots.

AREAS TO BE FITTED WITH MOTORCYCLE FRIENDLY DEVICES (Existing installations)

To a certain extent, choice of the appropriate device to be installed is left up to the responsible local authorities. Please refer to the summary chart in Annex VII

The lower beam (see 4.2) is suited for motorways and areas where the usual speed is above 50 km/h, whilst in the other cases, the CBP (4.1) is also appropriate.

Motorways and Interstate Highways

Accident records combined with a logical intuitive approach dictates that on exterior of curves of a radius less than 400m, in areas of high motorcycle traffic lower rail should be installed.

Crash barriers located on entries and exits of motorways are a choice candidate for receiving protective measures, as it is an area where acceleration and braking are combined with leaning the bike. Deceleration curves (exit of motorways and interstate highways): this is an area where the combined effect of sudden curve radius change, the necessary reduction of speed and the possible presence of diesel spillage on road surface poses a significant risk for a motorcycle.

The same applies to motorway interchange areas, where an added risk exists from lane changes by other vehicles accessing or exiting the motorway and pulling out in front of the motorcycle.

RINGS areas around major cities are the perfect area for receiving MFD as for an increasing proportion of commuters, the powered two wheeler is the vehicle of choice.

Country roads

The same principles applies to A roads, but because of the lower speeds practiced, the radius value of curves under which crash barriers should be equipped is 250 m. Fitting of MFD or CBP should continue for at least 50 m after the end of the curve.

Dangerous areas

Whatever the radius of the curve, road with gravel or slippery road, should be equipped with motorcycle friendly device whenever a crash barrier is present. The same applies to work areas or curves where the road surface is of poor quality.

As illustrated in 5) above, tricky bends where curve radius is not constant should be equipped with MFD. The same applies to areas where motorcycle accidents have already occurred in the past.



In all areas, regarding existing barriers, and in addition to the above recommendations, it is proposed that an approach consisting of **combining the**

experience of local road traffic & safety authorities with the input from local groups of motorcyclists is to be taken in order to decide where MFD / CBP are to be installed in priority. A specific effort should be made in the areas of regular biker meetings or areas attracting large number of motorcyclists, such as the "Bol d'Or" in France, the Faro Rally in Portugal, the 24 hour race at Spa-Francorchamp in Belgium, etc...

Because feedback on the actual effect of MFD/CBP in real life situation is insufficient for the moment, we recommend that **Europe Wide programme for equipping a significant number of crash barriers with motorcycle friendly devices** be launched. Surveying the feedback and results of this in the next years will allow accurate evaluation of the effect of MFD.



On a French road, a second lower flat rail is fitted under the armco (above: rail seen from behind)



An Austrian road with a crash barrier fitted with CBP polystyrene impact attenuator

7. Recommendations: areas for further research

- Regarding a closer study of effectiveness of MFD, two approaches can be taken:
 - Scientific study of crashes and testing through laboratory or computer crash simulation This can be undertaken relatively quickly, at affordable cost. This would allow comparison of shielding and foam impact attenuator approaches, as well as evaluating other approaches such as concrete wall
 - Case study of all motorcycle accidents with particular focus on areas equipped with MFD, in order to evaluate the effect of MFD and CBP. This requires a significant number of sites to be equipped with these MFD
- Research can also be conducted into innovative design for roadside barriers and should be encouraged.
- Additional research is necessary to compare the proposed solutions, which are presently tested with different homologation procedures. This can be performed either through real life testing but cost of testing and homologation procedure are very high. Real Life» Testing of throwing a dummy against a barrier costs 15 000 €. Computer simulation can be a alternate and cheaper solution.
- A European Type approval procedure for «motorcycle friendly crash barriers» should then be developed. This should be incorporated in CEN Norm EN1317, either by reviewing part 2 or by designing a new part 7.

Until such comparison is performed, a certain amount of common sense, or personal appreciation is needed, to evaluate which motorcycle friendly approaches to roadside is most appropriate to each road situation.

- Recommendations should also be tuned according to actual feedback and decided on the local level in consultation with riders groups.
- Academic research Evaluation of deceleration of a human body on a bush/shrub hedge should be made and should look into the types of bush/shrubs adapted to different climates/regions
- research into other infrastructure dangerous to motorcyclists (slippery white lines, bitumen, road hump, sidewalk edges [as illustrated below], other...) should be conducted and guidelines to take into account motorcyclists should be drawn.

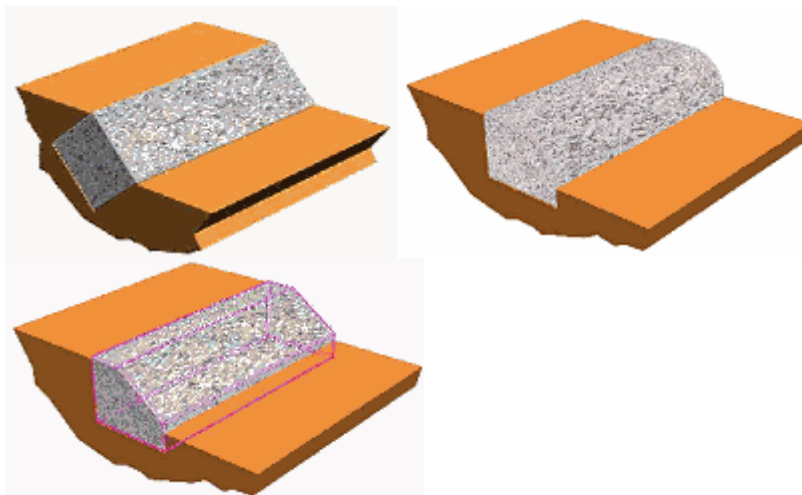

Fig. 10: making edges of sidewalks less aggressive to a fallen two-wheeler

List of abbreviations used

- RRL:** Road Research Laboratory
- TRL:** Transport Research Laboratory
- FEMA:** Federation of European Motorcyclists Associations
- FIM:** Federation Internationale de Motocyclisme
- BAST:** BundesAnsalts fur Strassenwesen- German Federal Bureau for Road Safety
- SETRA:** Service d'Etude Technique Routier et Autoroutier
- DSCR:** Direction de la Sécurité et de la Circulation Routière
- road safety branch of the french ministry of transport.
- IfZ:** Institute für Zweirad Sicherheit.
-Institute for Motorcycle Safety located in Essen
- INRETS:** Institut National pour la Recherche sur les Transports et leur Sécurité
- LIER:** Laboratoire de l'INRETS pour l'Equipement Routier
- ASI:** Abbreviated Scale of Injuries
- CB:** Crash Barrier
- CBP:** Crash Barrier Protector
- MFD:** Motorcycle-Friendly Device
- HIC:** Head Injury Criteria
-





FEMA
Rue des champs 62
1040 Bruxelles
Belgique

Tél: +32 2 736 90 47
Fax : +32 2 736 94 01

E-mail:
et_fema@compuserve.com